

Key Features:

- 4" coaxial two-way
- Waveguide coupled Ti tweeter
- Full bandwidth overload protection
- Front baffle wattage tap adjustment
- Integrated low loss matching transformer allows for either 70v/100v or 8-ohm operation
- Includes tile bridge and mounting ring for easy installation
- Integrated ported enclosure for extended bass response



General Description:

The Electro-Voice® EVID C4.2 loudspeaker system is a complete two-way ceiling loudspeaker package. The package consists of a bezel assembly, grille, rear enclosure, 4-inch coax two-way loudspeaker and internal line-matching transformer. The loudspeaker features a waveguide coupled titanium coated dome tweeter. The EVID C4.2 loudspeaker utilizes a 2nd order crossover network at 3.3 kHz, with a comprehensive protection circuit to protect the network, woofer, and tweeter drivers from excessive power levels. The C4.2 utilizes a transformer that offers a selection of 1.88 (70-V only), 3.75, 7.5, 15 or 30 watts delivered to the loudspeaker system using either 70-V or 100-V lines, or 8 ohm bypass. Selection is via a convenient switch on the front baffle. The perforated grille is finished in semi-gloss white powder-coated enamel. The baffle and bezel are constructed from UL 94V-0 rated ABS. The rear enclosure is constructed from zinc-plated, heavy gauge steel. The rear enclosure, with fiberglass damping material, provides an optimum internal volume for extended low-frequency performance. A rear cover, with provisions for a junction box fitting, provides access to a 4-pin terminal block that allows direct connection to the speaker with 12 gauge wire and provides pass through to additional speakers. A tile bridge is included for safe suspension of the C4.2 ceiling systems in a drop ceiling that uses mineral wool, or other fiber-based ceiling tiles. The EVID line of ceiling speakers has been designed to work together as a complete system in a wide range of different ceiling constructions. They provide wide dispersion, high-efficiency, high-maximum output, ease of installation, and wide-range reproduction of music or voice.

Technical Specifications:

Freq. Range (-10 dB):	65 Hz - 20 kHz
Coverage (Conical):	130°
Power Handling:	80 W Cont. / 320 W Peak
Sensitivity (SPL 1W/1m):	86 dB
Max Calculated SPL:	110 dB
Impedance:	8 Ohms nominal (transformer bypass)
Network:	Network and transducers protected, 12 dB/oct 3.3 kHz
LF Transducer:	4 in. (100 mm) Polypropylene cone
HF Transducer:	.75 in (19 mm) Ti Mylar laminate
Transformer Taps:	70V: 1.88, 3.75, 7.5, 15 or 30W 100V: 3.75, 7.5, 15 or 30W Bypass: 8 Ohms
Connectors:	Phoenix type removable, with screw terminals and "loop-thru", accepts 12 ga wire
Enclosure Material:	Baffle - UL 94V-O rated ABS Backcan - Zinc plated steel
Grille:	Perforated powder coated steel with safety tether
Support Hardware:	Tile bridge, backing plate support, cutout template, paint shield
Dim (H x Dia.):	6.9" x 7.1" (176mm x 181mm)
Cutout Size:	7.25" (184mm)
Net Weight (each):	6.0 lbs (2.7 kg)
Shipping Weight (pair):	14.0 lbs (6.4 kg)

All Specifications based on Half Space Environment in ceiling.

Architects' & Engineers' Specifications:

The EVID C4.2 loudspeaker system shall be comprised of a UL 94V-0 fire rated ABS baffle/bezel assembly, zinc plated steel rear enclosure, powder coated grille with safety tether, transformer with 8 ohm bypass and 4-inch polypropylene low frequency transducer with coaxially-mounted waveguide loaded 3/4-inch titanium coated dome tweeter. The loudspeaker shall meet the following criteria: power rating shall be 80 watts of EIA RS-426A pink noise (6 dB crest factor). Frequency response, uniform from 65 Hz to 20 Hz. Pressure sensitivity, 86 dB SPL at 1 meter (3.3 feet) on axis with one watt of pink noise (ref. 20 μ Pa). Minimum impedance, 6.0 ohms. The loudspeaker shall be 181 mm (7.1 in.) in diameter and 176 mm (6.9 in.) deep. Weight shall be 2.7 kg. (6.0 lb) The coaxial ceiling loudspeaker shall be the Electro-Voice® model EVID C4.2.

Frequency Response:

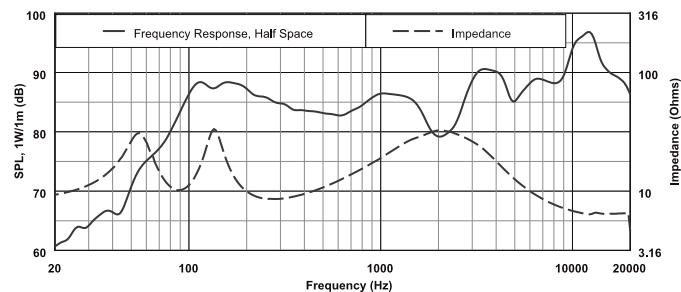

Block Diagram:

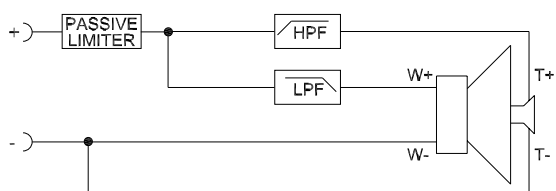

Beamwidth:

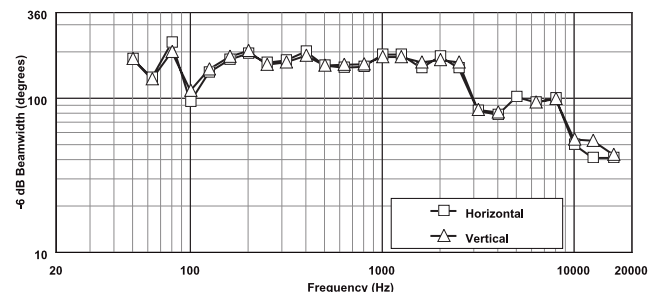

Dimension Drawings:

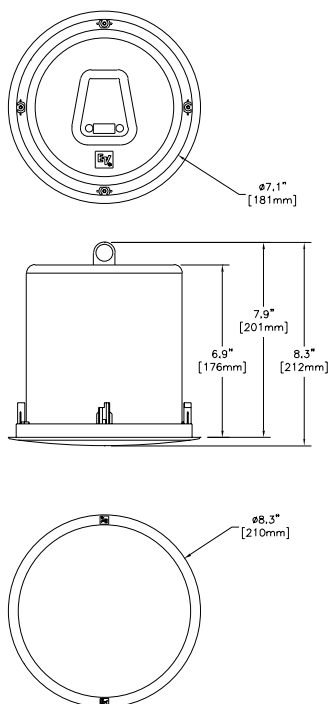

Directivity:

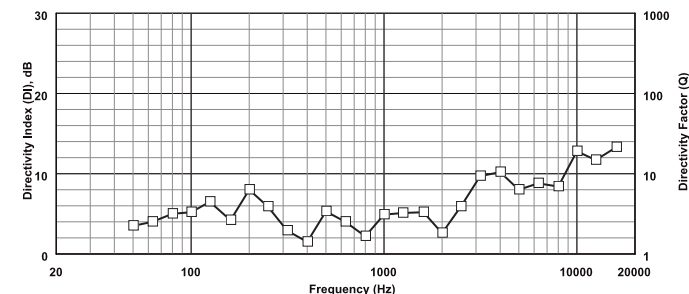

Performance Match:

- EVID C10.1 Subwoofer
- CPS-1 Power Amplifier
- CPS-2 Power Amplifier
- CPS-2T Power Amplifier
- MA-1206 Mixer Amplifier
- MA-1212 Mixer Amplifier

EVID C4.2 Part Number

- 301258-000



12000 Portland Avenue South, Burnsville, MN 55337
Phone: 952/884-4051, Fax: 952/884-0043

www.electrovoice.com

© Telex Communications, Inc. 8/2002

Part Number 38110-125 Rev B

U.S.A. and Canada only. For customer orders, contact Customer Service at:

800/392-3497 Fax: 800/955-6831

Europe, Africa, and Middle East only. For customer orders, contact Customer Service at:

+ 49 9421-706 0 Fax: + 49 9421-706 265

Other International locations. For customer orders, contact Customer Service at:

+ 1 952 884-4051 Fax: + 1 952 887-9212

For warranty repair or service information, contact the Service Repair department at:

800/685-2606

For technical assistance, contact Technical Support at: 866/78AUDIO

Specifications subject to change without notice.